

P 2

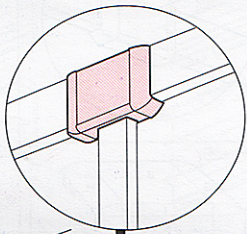

P 3

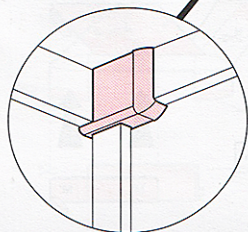

P 4/5/6/7

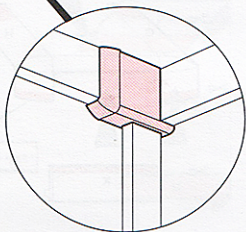

P 8/9/10/11

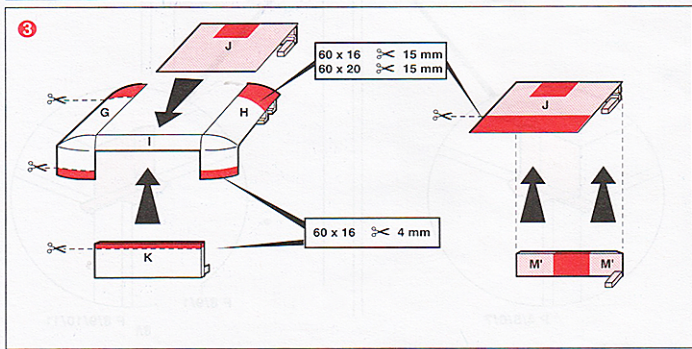
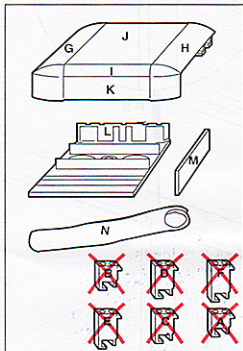
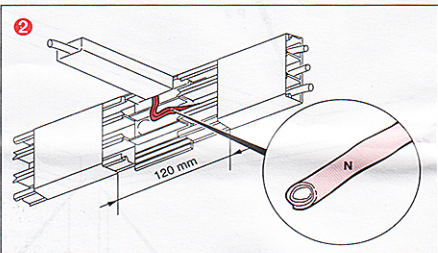
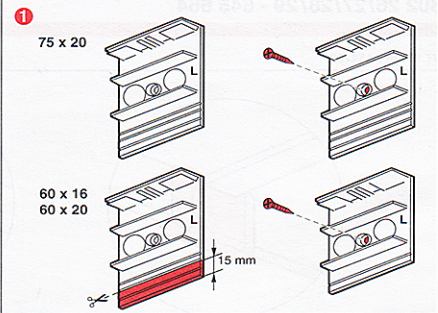
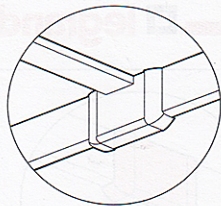

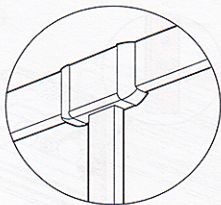

1

75 x 20

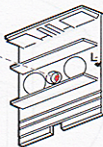
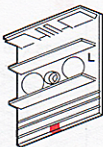

60 x 16
60 x 20

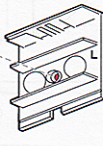
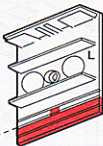

15 mm

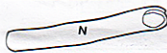
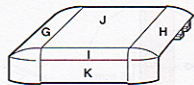

2

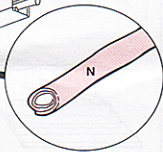
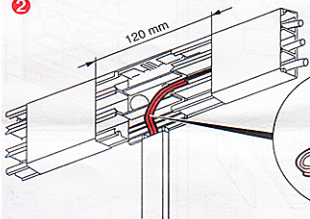

3

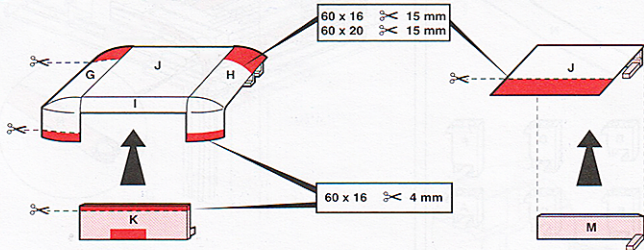

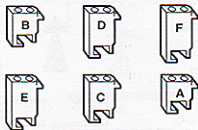
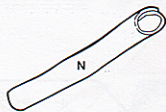
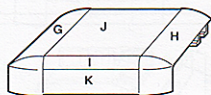
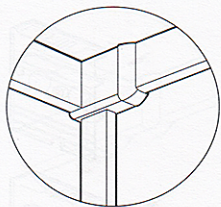

1

75 x 20

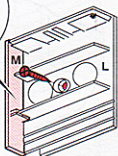
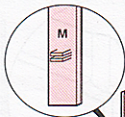
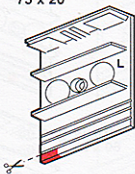

60 x 16
60 x 20

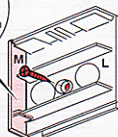
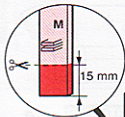
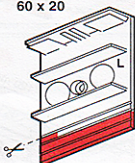

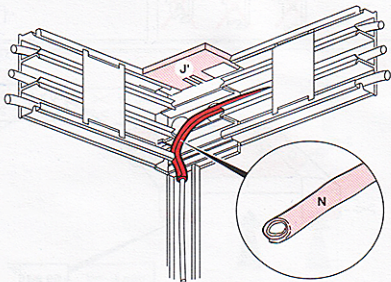

3

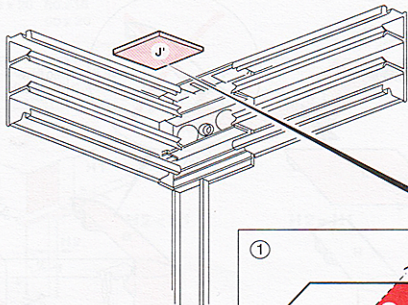

2



75 x 20  23 mm
 60 x 16  19 mm
 60 x 20  23 mm

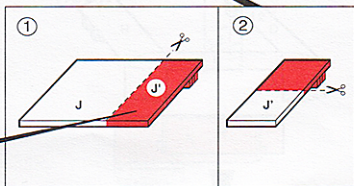

4

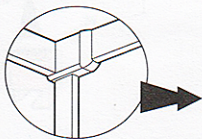
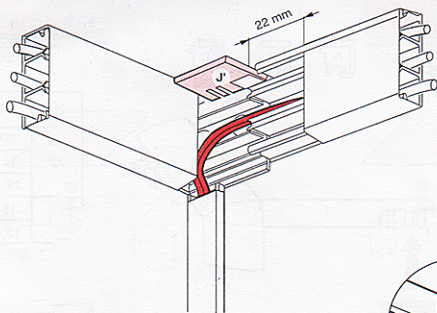

5

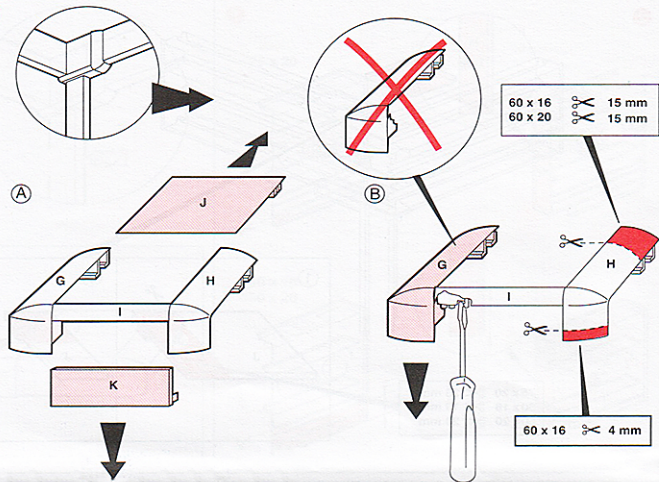

C

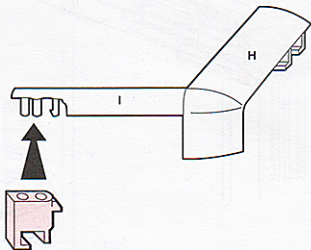
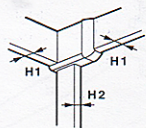

H1	H2	
20	20	A
	16	B
	12,5	D
16	16	A
	12,5	B

Ⓓ

75 x 20 60 x 16
60 x 20

60 x 16 $\frac{1}{2}$ 15 mm
60 x 20 $\frac{1}{2}$ 15 mm

75 x 20 $\frac{1}{2}$ 23 mm
60 x 16 $\frac{1}{2}$ 19 mm
60 x 20 $\frac{1}{2}$ 23 mm

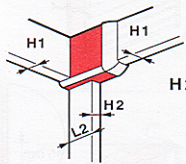
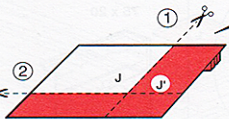

$H2 < H1$

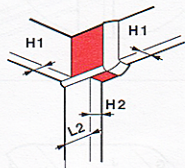

$H2 = H1$

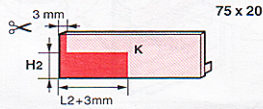

75 x 20

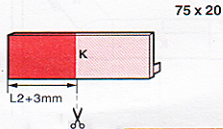

75 x 20

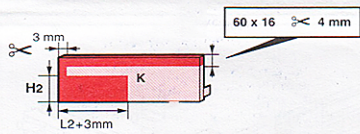

60 x 16 $\frac{1}{2}$ 4 mm

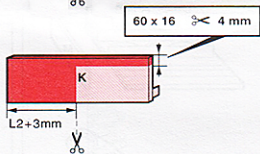

60 x 16 $\frac{1}{2}$ 4 mm

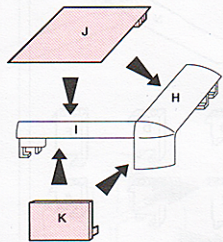
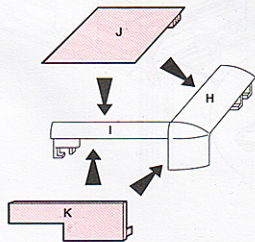

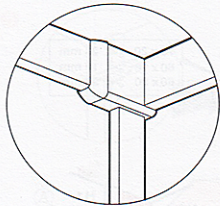

1

75 x 20

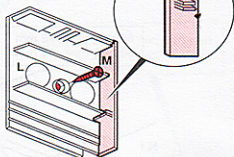
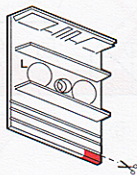

60 x 16
60 x 20

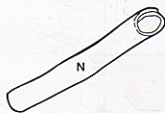
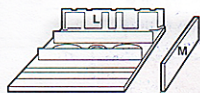
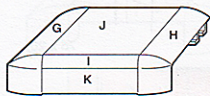
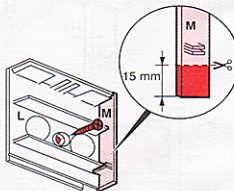
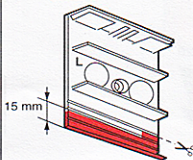

3

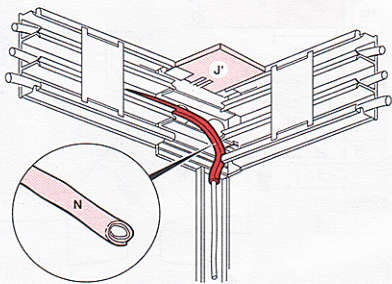

2

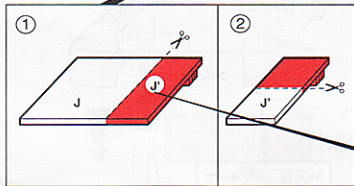
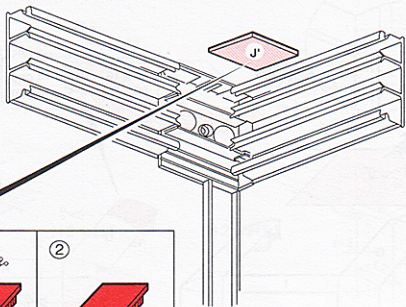

75 x 20		23 mm
60 x 16		19 mm
60 x 20		23 mm

4

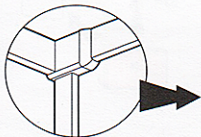
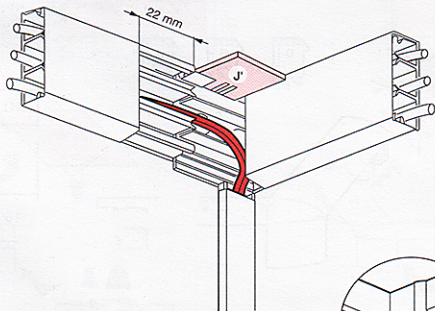

5

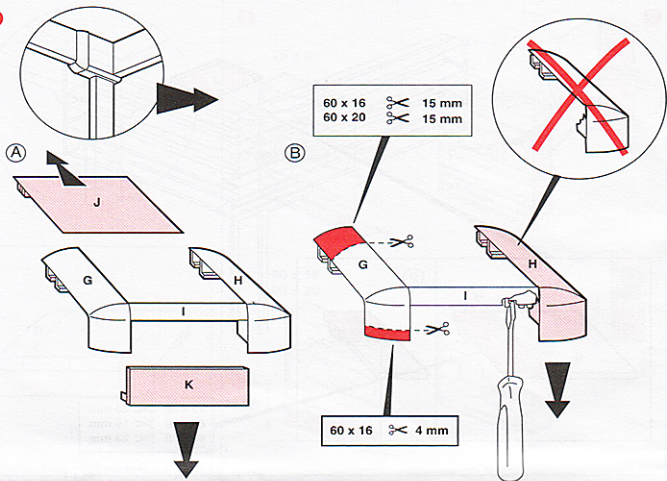

C

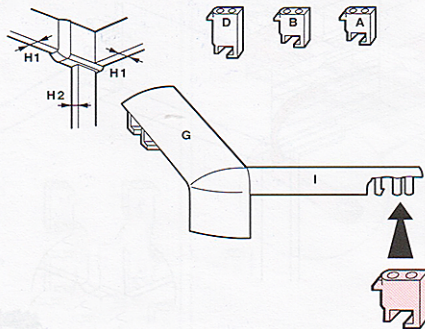

H1	H2	
20	20	A
	16	B
	12,5	D
16	16	A
	12,5	B

Ⓓ

75 x 20 60 x 16
60 x 20

75 x 20 $\varnothing < 23$ mm
60 x 16 $\varnothing < 19$ mm
60 x 20 $\varnothing < 23$ mm

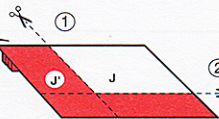

60 x 16 $\varnothing < 15$ mm
60 x 20 $\varnothing < 15$ mm

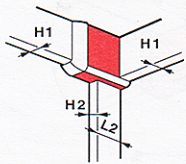

$H2 < H1$

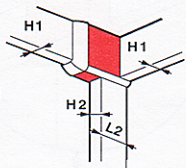

$H2 = H1$

75 x 20

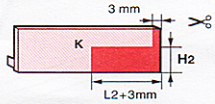

75 x 20

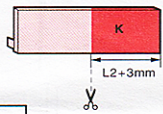

60 x 16 $\varnothing < 4$ mm

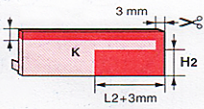

60 x 16 $\varnothing < 4$ mm

